

Compatible Accessories

This security camera has several mounting options:

Accessories	Model Numbers
Junction Boxes	S4JF4G (circular) / S1JF4G (square)
Wall Mount	S1WA2G
Pole Mounts	S4PA2G with S1WA2G, or S1PA2G with S4JF4G
Corner Mounts	S1RA2G with S4JF4G

Safety Precautions

- Use an appropriate low-voltage power cable to prevent fire or electrical shock.
- Make sure to install the camera in an area that can support the camera weight.
- There are no user-serviceable parts inside the camera. Please do not disassemble the camera.
- Do not clean the lens cover with an abrasive cleaning material. Please use a soft cloth to clean the lens cover.
- Camera is rated for outdoor use (IP66), but is not intended for submersion in water.
- Extend the Ethernet-cable run for your camera up to 300ft. You can use an RJ45 coupler or network switch to connect male ends of Ethernet cable together. A maximum of 3 connections is recommended.

Weights & Dimensions

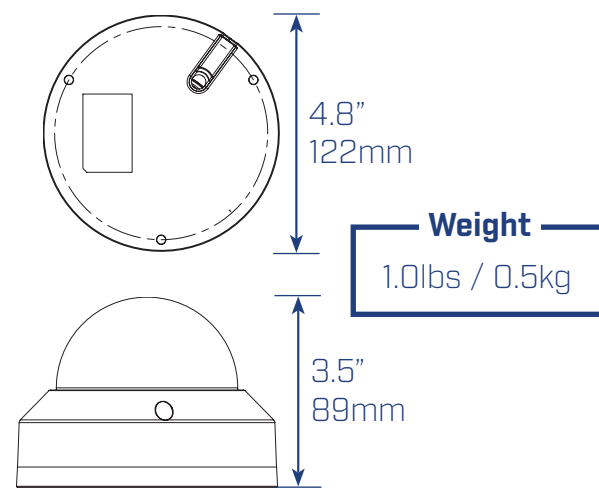

Using the RJ45 Cap (Optional)

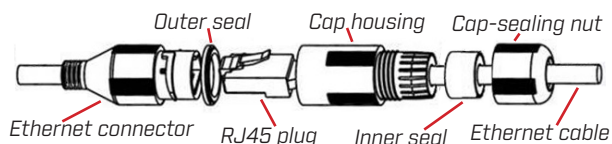

- 1 Fit the outer seal over your camera's Ethernet connector and insert the inner seal into the cap housing.
- 2 Run the stripped end of an Ethernet cable through the parts of the RJ45 cap, as shown above.
- 3 Terminate the Ethernet cable with an RJ45 plug, and plug the cable into your camera's Ethernet connector.
- 4 Screw the cap housing onto the Ethernet connector
- 5 Screw the cap-sealing nut tightly into the cap housing.

ATTENTION:

The supplied RJ45 cap is weather-resistant. Seal the cap with silicone if it will be exposed to precipitation regularly.

FCC Notice

This equipment has been tested and found to comply with the limits for a Class A digital device, pursuant to Part 15 of the FCC Rules. These limits are designed to provide reasonable protection against harmful interference when the equipment is operated in a commercial environment. This equipment generates, uses, and can radiate radio frequency energy and, if not installed and used in accordance with the instruction manual, may cause harmful interference to radio communications. Operation of this equipment in a residential area is likely to cause harmful interference in which case the user will be required to correct the interference at his own expense.

IT'S ALL ON THE WEB!

VISIT
flir.com/security/pro

FLIR Systems, Inc., Copyright © 2016

As our products are subject to continuous improvement, FLIR Systems Inc. reserves the right to modify product design, specifications and prices, without notice and without incurring any obligation. E80E



N247V3_SERIES_QSG_EN_R1

3MP Motorized Varifocal Lens Network Vandal Dome Camera

QUICK START GUIDE

MODEL: N247V3

English Version 1.0



FLIR IP™

flir.com/security/pro

Package Contents

- 1× 3MP Motorized Varifocal Lens Network Vandal Dome Camera
- 3× Mounting Screws & Drywall Anchors
- 1× Allen Key
- 1× Mounting Template
- 1× RJ45 Cap

Camera Overview

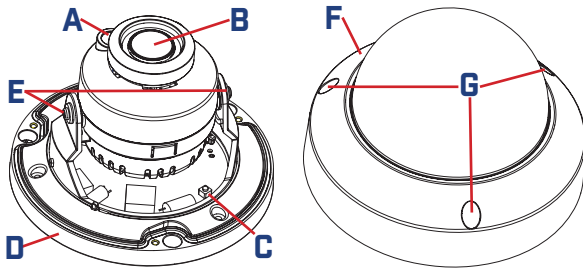

- A. Light Sensor and IR LEDs**
- B. Lens**
- C. Reset Button:** See “Resetting the Camera” for details.
- D. Camera Base**
- E. Adjustment Screws (×2)**
- F. Dome Cover**
- G. Dome Cover Screws (×3)**

Connecting the Camera

- A Ethernet Connector:** Connect the camera to an NVR or a router or switch on your network using CAT5e or better Ethernet cable (not included). PoE Class 3 supported.

NOTE: For instructions on weatherproofing the Ethernet connection, see “Using the RJ45 Cap (Optional)” on the back of this guide.

- B Power Input:** If not using PoE, connect the camera to a 12V DC power source (420mA or higher required).

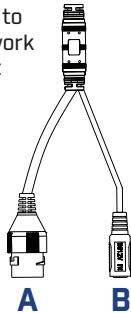

Installing the Camera

ATTENTION:

Test the camera prior to selecting a permanent mounting location by temporarily connecting the camera(s) and cables to the NVR.

- 1 Use the included Allen key to loosen the screws on the dome cover. Remove the dome cover.
- 2 Use the included mounting template to mark holes for the mounting screws and camera cable.
- 3 Drill holes for the mounting screws and camera cable.
NOTE: Use the included drywall anchors if needed
- 4 Connect cables as shown in the section “Connecting the Camera”.
- 5 Attach the camera base to the mounting surface using the included mounting screws (3×).

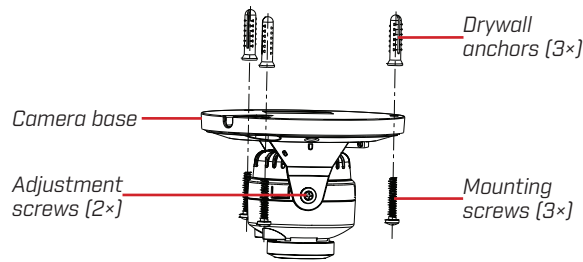

- 6 Set the position and angle of the camera:
A) Rotate the camera around the base (rotates 360° before stopping).
B) Use a Phillips screwdriver to loosen the adjustment screws. Tilt the camera. Tighten both screws when finished.
C) Adjust the position of the camera lens by twisting.

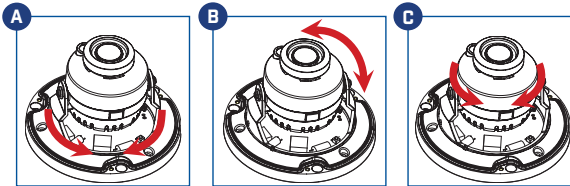

- 7 Replace the dome cover. Use the included Allen key to tighten the dome cover screws (3×).

ATTENTION:

Make sure IR LEDs are not blocked by the dome cover to prevent IR reflection.

- 8 Remove the vinyl film from the dome cover.

Adjusting Zoom and Focus

Adjust the camera’s zoom and focus using an NVR or the web interface. For more information, see your NVR’s instruction manual on www.flir.com/security/pro.

- 1 **NVR:** Right-click on the camera’s live view and then click **AutoFocus**. Use the sliders to adjust the zoom and focus.

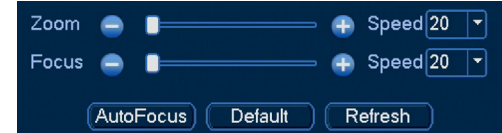

- 2 **Web Interface:** Use the controls in the right-hand panel to adjust the zoom and focus.

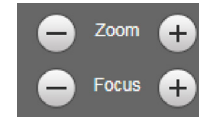

Resetting the Camera

- 1 Remove the dome cover. Make sure the camera is powered on.
- 2 Press and hold the reset button on the camera base for 5 seconds to reset the camera to default settings.

