

Copyright

© 2018, FLIR Systems, Inc.

All rights reserved worldwide. Names and marks appearing herein are either registered trademarks or trademarks of FLIR Systems and/or its subsidiaries. All other trademarks, trade names or company names referenced herein are used for identification only and are the property of their respective owners.

Document identity

Publ. No.: LX400031
 Commit: 48293
 Head: 48293
 Language: en-US
 Modified: 2018-03-15
 Formatted: 2018-03-15

Website

www.flir.com/security/pro

Technical Support

1-800-254-0632

Customer Service

1-866-344-4674

Legal disclaimer







Specifications subject to change without further notice. Camera models and accessories subject to regional market considerations. License procedures may apply. Products described herein may be subject to US Export Regulations. Please refer to exportquestions@flir.com with any questions.

1 FLIR Network Camera Mount Accessories Compatibility







FLIR offers a wide variety of different mounts for flexible camera installation. This document shows which FLIR mounts are available for each camera.

TIP: Press **CTRL+F** to quickly search for your camera model or accessory.











1.1 Network Cameras

Camera Models	Compatible Accessories
 N253EA8	<p><i>Junction Box</i></p>  S4JF5G
	<p><i>Wall Mount</i></p>  S1WA1G
	<p><i>Pole Mounts</i></p>  S4PA2GS with S1WA1G  S4PA2GS with S4JF5G
	<p><i>Corner Mount</i></p>  S1RA2G with S4JF5G







© 2018, FLIR Systems, Inc.
 #LX400031; r. 48293/; en-US

Camera Models	Compatible Accessories
 <p>N357EA8</p>	<p><i>Junction Box</i></p>  <p>S4JF4G</p>
	<p><i>Wall Mount</i></p>  <p>S1WA2G</p>
	<p><i>Pole Mounts</i></p>  <p>S4PA2GS with S1WA2G</p>  <p>S4PA2GS with S4JF4G</p>
	<p><i>Corner Mount</i></p>  <p>S1RA2G with S4JF4G</p>









© 2018, FLIR Systems, Inc.
 #LX400031; r. 48293/; en-US

Camera Models	Compatible Accessories
<div data-bbox="743 373 894 478" data-label="Image">  </div> <p data-bbox="784 499 854 525">N258F5</p>	<p data-bbox="1219 359 1338 384"><i>Junction Box</i></p> <div data-bbox="1235 405 1321 485" data-label="Image">  </div> <p data-bbox="1240 512 1317 537">S1JF4G</p> <div data-bbox="1230 548 1321 615" data-label="Image">  </div> <p data-bbox="1240 632 1317 657">S4JF2G</p>
	<p data-bbox="1227 667 1333 693"><i>Wall Mount</i></p> <div data-bbox="1230 709 1328 772" data-label="Image">  </div> <p data-bbox="1235 793 1321 819">S1WA2G</p>
	<p data-bbox="1219 831 1338 856"><i>Pole Mounts</i></p> <div data-bbox="1154 869 1403 953" data-label="Image">  </div> <p data-bbox="1170 968 1386 993">S4PA2GS with S1WA2G</p> <div data-bbox="1154 1014 1403 1098" data-label="Image">  </div> <p data-bbox="1170 1121 1386 1146">S4PA2GS with S1JF4G</p> <div data-bbox="1154 1161 1403 1245" data-label="Image">  </div> <p data-bbox="1170 1262 1386 1287">S4PA2GS with S4JF2G</p>
	<p data-bbox="1219 1295 1338 1320"><i>Corner Mount</i></p> <div data-bbox="1162 1341 1398 1425" data-label="Image">  </div> <p data-bbox="1179 1436 1382 1461">S1RA2G with S1WA2G</p> <div data-bbox="1162 1478 1398 1562" data-label="Image">  </div> <p data-bbox="1179 1585 1382 1610">S1RA2G with S1JF4G</p> <div data-bbox="1162 1625 1398 1709" data-label="Image">  </div> <p data-bbox="1179 1724 1382 1749">S1RA2G with S4JF2G</p>



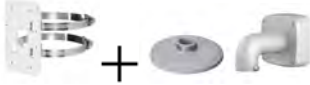
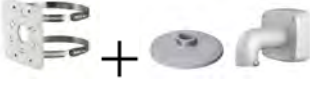





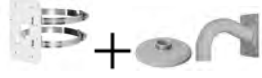

© 2018, FLIR Systems, Inc.
 #LX400031; r. 48293/; en-US

Camera Models	Compatible Accessories
 N243MW2	<p><i>Junction Box</i></p>  S4JF5G
	<p><i>Wall Mount</i></p>  S1WA1G
	<p><i>Pole Mounts</i></p>  S4PA2G (EOL) with S1WA1G  S4PA2GS with S1WA1G  S1PA2G with S4JF5G
	<p><i>Corner Mount</i></p>  S1RA2G with S4JF5G





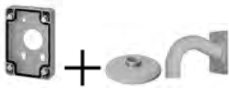









© 2018, FLIR Systems, Inc.
 #LX400031; r. 48293/; en-US

Camera Models	Compatible Accessories
 <p>N347VW4 N357V8</p>	<p><i>Junction Box</i></p>  <p>S4JF6G</p>
	<p><i>Wall Mount</i></p>  <p>S6WF1G</p>
	<p><i>Pendant Cap</i></p>  <p>S6PCF1G</p>
	<p><i>Pole Mounts</i></p>  <p>S4PA2G (EOL) with S6WF1G</p>  <p>S4PA2GS with S6WF1G</p>  <p>S1PA2G with S6CF1G</p>
	<p><i>Corner Mount</i></p>  <p>S1RA2G with S6WF1G</p>
	<p><i>Ceiling Mount</i></p>  <p>S6CF1G</p>

© 2018, FLIR Systems, Inc.
#LX400031; r. 48293; en-US







Camera Models	Compatible Accessories
 <p>N437VDL / N437VDLP N437VEW / N437VEWP</p>	<p><i>Pole Mount</i></p>  <p>S4PA2G (EOL) with S1WA3G</p>  <p>S4PA2GS with S1WA3G</p>  <p>S4PA2G (EOL) with S1JF5G</p>  <p>S4PA2GS with S1JF5G</p>  <p>S1PA2G with S1WA3G</p>
	<p><i>Wall Mount</i></p>  <p>S1WA3G</p>
	<p><i>Ceiling Mount</i></p>  <p>S1CA2G</p>
	<p><i>Corner Mount</i></p>  <p>S1RA2G with S1WA3G (S1JA2G optional)</p>
	<p><i>Junction Box</i></p>  <p>S1JA2G with S1WA3G</p>  <p>S1JF5G</p>

© 2018, FLIR Systems, Inc.
#LX400031; r. 48293; en-US









Camera Models	Compatible Accessories
 N336ZD1 / N336ZD1P  N336ZD3 / N336ZD3P  N346ZW124  N446ZC302	<p><i>Pole Mount</i></p>  S1PA2G  S1PA2G with S1PBZ2G  S1PA2G with S1JA2G
	<p><i>Ceiling Mount</i></p>  S1CA2G*  S1CA2G* with S1PA2G
	<p><i>Corner Mount</i></p>  S1RA2G  S1RA2G with S1PBZ2G  S1RA2G with S1JA2G
	<p><i>Surveillance Cabinet</i></p>  S1PBZ2G
	<p><i>Junction Box</i></p>  S1JA2G

* Pendant cap not used.









© 2018, FLIR Systems, Inc.
 #LX400031; r. 48293; en-US

Camera Models	Compatible Accessories
 <p>N233ZC / N233ZCP N233ZD / N233ZDP</p>	<p><i>Pole Mount</i></p>  <p>S4PA2G (EOL) with S1WA2G</p>  <p>S4PA2GS with S1WA2G</p>  <p>S4PA2G (EOL) with S1JF4G</p>  <p>S4PA2GS with S1JF4G</p>
	<p><i>Wall Mount</i></p>  <p>S1WA2G</p>
	<p><i>Junction Box</i></p>  <p>S1JF4G</p>









© 2018, FLIR Systems, Inc.
#LX400031; r. 48293/; en-US

Camera Models	Compatible Accessories
 N253V8 N243VW4  N233VE / N233VEP	<p><i>Pole Mount</i></p>  S4PA2G (EOL) with S1WA2G  S4PA2GS with S1WA2G  S1PA2G with S4JF2G
	<p><i>Wall Mount</i></p>  S1WA2G
	<p><i>Corner Mount</i></p>  S1RA2G with S4JF2G
	<p><i>Junction Box</i></p>  S4JF2G



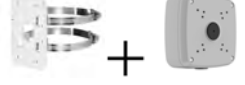





© 2018, FLIR Systems, Inc.
#LX400031; r. 48293/; en-US

Camera Models	Compatible Accessories
 N247V3  N237VE / N237VEP	<p><i>Pole Mount</i></p>  S4PA2G (EOL) with S1WA2G  S4PA2GS with S1WA2G  S1PA2G with S4JF4G
	<p><i>Wall Mount</i></p>  S1WA2G
	<p><i>Corner Mount</i></p>  S1RA2G with S4JF4G
	<p><i>Junction Box</i></p>  S4JF4G  S1JF4G

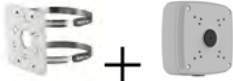







© 2018, FLIR Systems, Inc.
#LX400031; r. 48293; en-US

Camera Models	Compatible Accessories
 <p>N133EB / N133EBP N133ED / N133EDP N233EE / N233EEP</p>  <p>N243EW2 N243EW4</p>  <p>P143E4 PE133E / PE133EP PE133F / PE133FP</p>	<p><i>Pole Mount</i></p>  <p>S4PA2G (EOL) with S1WA1G</p>  <p>S4PA2GS with S1WA1G</p>  <p>S4PA2G (EOL) with S1JF2G</p>  <p>S4PA2GS with S1JF2G</p>
	<p><i>Wall Mount</i></p>  <p>S1WA1G</p>
	<p><i>Junction Box</i></p>  <p>S1JF2G</p>  <p>S4JF1G</p>

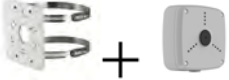



© 2018, FLIR Systems, Inc.
#LX400031; r. 48293/; en-US

Camera Models	Compatible Accessories
 N357B8 / N357BL8  N347BW4	<p><i>Pole Mount</i></p>  S4PA2G (EOL) with S1JF2G  S4PA2GS with S1JF2G
 N253B8 N243BW2 N243BW4	<p><i>Corner Mount</i></p>  S1RA2G with S1JF2G
 N437BDL / N437BDLP N437BEW / N437BEWP  N133BB / N133BBP N133BD / N133BDP N233BE / N233BEP	<p><i>Junction Box</i></p>  S1JF2G





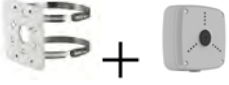



© 2018, FLIR Systems, Inc.
#LX400031; r. 48293/; en-US

Camera Models	Compatible Accessories
 <p>N247B3 N237BE / N237BEP</p>	<p><i>Pole Mount</i></p>  <p>S4PA2G (EOL) with S1JF3G</p>  <p>S4PA2GS with S1JF3G</p>  <p>S1PA2G with S4JF3G</p>
	<p><i>Corner Mount</i></p>  <p>S1RA2G with S1JF3G</p>  <p>S1RA2G with S4JF3G</p>
	<p><i>Junction Box</i></p>  <p>S1JF3G</p>  <p>S4JF3G</p>









© 2018, FLIR Systems, Inc.
#LX400031; r. 48293/; en-US

Camera Models	Compatible Accessories
 <p>P143B4 PB133F / PB133FP</p>	<p><i>Pole Mount</i></p>  <p>S4PA2G (EOL) with S1JF3G</p>  <p>S4PA2GS with S1JF3G</p>
	<p><i>Corner Mount</i></p>  <p>S1RA2G with S1JF3G</p>
	<p><i>Junction Box</i></p>  <p>S1JF3G</p>





© 2018, FLIR Systems, Inc.
#LX400031; r. 48293/; en-US

Camera Models	Compatible Accessories
 DNB23TF2 / DNB23TF2P	<p><i>Pole Mount</i></p>  S4PA2G (EOL) with MNTNB2XJW  S4PA2GS with MNTNB2XJW
 DNB13TF2 / DNB13TF2P	<p><i>Corner Mount</i></p>  MNTNX1R with MNTNB2XJW
 DNE12TL2 / DNE12TL2P	<p><i>Junction Box</i></p>  MNTNB2XJW  MNTNB1XJ
 DNB16M2 / DNB16M2P	









© 2018, FLIR Systems, Inc.
 #LX400031; r. 48293/; en-US

Camera Models	Compatible Accessories
 <p>DNZ30TL2R / DNZ30TL2RP</p>	<p><i>Pole Mount</i></p>  <p>MNTNX1P</p>  <p>MNTNX1P with MNTZX1PB</p>
	<p><i>Ceiling Mount</i></p>  <p>MNTNZ30C</p>
	<p><i>Corner Mount</i></p>  <p>MNTNX1R</p>  <p>MNTNX1R with MNTZX1PB</p>
	<p><i>Surveillance Cabinet</i></p>  <p>MNTZX1PB</p>
	<p><i>Junction Box</i></p>  <p>S1JA2G</p>

© 2018, FLIR Systems, Inc.
 #LX400031; r. 48293; en-US

Camera Models	Compatible Accessories
 <p data-bbox="711 474 928 499">DNV16M2 / DNV16M2P</p>	<p data-bbox="1224 361 1331 386"><i>Pole Mount</i></p>  <p data-bbox="1149 541 1409 567">MNTN1XP with MNTNV16W</p>
	<p data-bbox="1224 579 1331 604"><i>Wall Mount</i></p>  <p data-bbox="1224 760 1338 785">MNTNV16W</p>
	<p data-bbox="1224 798 1338 823"><i>Ceiling Mount</i></p>  <p data-bbox="1224 1050 1338 1075">MNTNV16C</p>
	<p data-bbox="1224 1083 1338 1108"><i>Corner Mount</i></p>  <p data-bbox="1149 1268 1409 1293">MNTNX1R with MNTNV16W</p>

© 2018, FLIR Systems, Inc.
#LX400031; r. 48293; en-US

Camera Models	Compatible Accessories
 <p>DNV14TL2 / DNV14TL2P DNV14UX2 / DNV14UX2P</p>	<p><i>Pole Mount</i></p>  <p>MNTV2XP with MNTV2XW</p>
	<p><i>Wall Mount</i></p>  <p>MNTV2XW — Wall Mount</p>
	<p><i>Ceiling Mount</i></p>  <p>MNTV2XC — Ceiling Mount</p>  <p>MNTV2XPC — Pendant Cap</p>
	<p><i>Corner Mount</i></p>  <p>MNTV2XR with MNTV2XW</p>
	<p><i>Junction Boxes</i></p>  <p>MNTV2XB (Compatible with MNTV2XW and MNTV2XC)</p>  <p>MNTV2XJ with MNTV2XW</p>